

# NATIONAL RAILWAY SUPPLY

Installing, Operating and  
Service Instructions for the  
12/40 Solid State Charger

---

## MODEL ELC-12/40-M-D BATTERY CHARGER

---

### PLEASE SAVE THESE IMPORTANT SAFETY AND OPERATING INSTRUCTIONS

For correct operation of the equipment, it is important to read and be familiar with this entire manual before installing and operating the charger.  
**DO NOT DISCARD THIS MANUAL AFTER READING.**



**LOOK FOR THIS SYMBOL TO POINT OUT SAFETY PRECAUTIONS. IT MEANS: BECOME ALERT—YOUR SAFETY IS INVOLVED. IF YOU DO NOT FOLLOW THESE SAFETY INSTRUCTIONS, INJURY OR PROPERTY DAMAGE CAN OCCUR.**

#### 1. IMPORTANT SAFETY INSTRUCTIONS

- a. Before using the battery charger, read all the instructions and caution markings on the battery charger, the battery, and all of the products using the battery.
- b. Do not touch the uninsulated parts of the AC input or the DC wires, the charger's binding posts, or the battery terminals, as there is a possibility of electrical shock.
- c. Batteries produce hydrogen gas while operating, which can explode if ignited. Never smoke, use an open flame, or create sparks in the vicinity of the battery. Ventilate the area well when the battery is charging in an enclosed area.
- d. Batteries contain caustic material which may cause burns. Do not get in eyes, on skin, or clothing. If the gelled or liquid content of the batteries contacts the skin or clothing, wash the area thoroughly with water. In the case of contact with the eyes, flush immediately with clean water for 15 minutes and obtain medical attention.
- e. Only qualified personnel should program or service this equipment.
- f. De-energize all AC and DC power connections before servicing this unit. If injury does occur, apply standard treatment for electrical shock and, if necessary, consult with a physician.
- g. The charger is not for outdoor use. Do not expose the charger to rain or snow.
- h. Do not operate the charger if it has received a sharp blow, been dropped, or otherwise damaged.
- i. Do not disassemble the charger. Have the charger examined by a NATIONAL RAILWAY SUPPLY service agent. If the charger is assembled incorrectly, damage to the charger and the batteries or an electrical shock may result.

#### 2. DESCRIPTION

The NATIONAL RAILWAY SUPPLY charger, model 12/40, is a convection-cooled, solid state, SCR regulated charger that provides either a constant current or constant voltage output. The charger can be set to charge batteries within a voltage range of 10.00 to 17.00 volts for gel-cell, liquid lead-acid, nickel cadmium, nickel iron, and starved electrolytic batteries.

### 3. THEORY OF OPERATION

When the charger is connected to the desired AC voltage source (115 or 230), the transformer creates auxiliary voltages for the electronic control module. The electronic control module controls and monitors the charger so it will perform properly. The transformer also supplies the power output used for charging the batteries and provides electrical isolation between the charger's output and the AC source.

The charger's output current flows through a shunt and is sensed by the electronic control module along with the charger's output voltage. These values are converted into drive pulses for the SCRs by the control module. This pulsating charge current (a pulse occurs each time an SCR is on) is then filtered by a large capacitor and the batteries to provide a smooth output.

The charger has an "IE" profile which is: (a) High rate constant current, and (b) Constant voltage. When the charger is first started, the SCRs will conduct for a certain portion of the sinusoidal anode voltage to provide the required charging current at the low level of battery voltage. In this start region, a constant current is applied to the battery. The SCR conduction will then increase as the battery voltage increases in order to provide a higher output voltage while maintaining a constant charging current.

When the battery voltage reaches the float voltage, the SCRs will start to decrease their output. This causes the charger to automatically change from a constant current charge region to a constant voltage charge region. As the batteries become fully charged, the output current decreases. A continuous constant float voltage will be supplied to the batteries to maintain their charge.

Another feature of the charger is temperature compensation, which keeps the batteries from getting under- or over-charged. **TEMPERATURE COMPENSATION ONLY OCCURS WHEN USING A TEMPERATURE PROBE.** The red LED on the front of the charger will be off when using a functional temperature probe. If the LED is on, either a temperature probe is not being used, or the temperature probe is working improperly.

Temperature compensation uses a temperature reference of 77°F (25°C), a voltage reference of 2.23 volts (the voltage of a standard gel-cell battery at 77°F), and a compensation value of 3.0 mV per °F). The equivalent equation for the compensated voltage is:

$$V_{\text{comp}} = V - k(t - 77^{\circ}\text{F})$$

Where V is the voltage of the battery at 77°F, t is the temperature in °F, and  $k = V (.003 / 2.23)$ .

The control module has a temperature compensation range between 32°F and 95°F ( 0°C and 35°C) that does not allow charger voltage to increase or decrease beyond the calculated values.

#### Example 1:

If a 13.38 volt battery is charging and the temperature increases to 95°F, then the output voltage decreases to 13.06 volts.

$$13.38 - .018 (95^{\circ}\text{F} - 77^{\circ}\text{F}) = 13.06$$

#### Example 2:

If a 14.50 volt battery is charging and the temperature increases to 95°F, then the output voltage decreases to 14.15 volts.

$$14.50 - .0195 (95^{\circ}\text{F} - 77^{\circ}\text{F}) = 14.15$$

#### Example 3:

If 15.61 volt batteries are charging and the temperature decreases to 32°F, the output voltage increases to 16.56 volts.

$$15.61 - .021 (32^{\circ}\text{F} - 77^{\circ}\text{F}) = 16.56$$

### 4. RECEIVING AND INSTALLING THE CHARGER

Proper installation of the charger is important in order to achieve good charger performance and to prevent damage to the charger and batteries. When a charger is received, a check for possible in-transit damage should be made. If any damage is found, it should be reported as a claim to the carrier. To permit free air flow for convection cooling, allow two inches (2") minimum between the charger sides and other equipment and four inches (4") minimum on top of the charger.

 **WARNING: NEVER PLACE ANYTHING ON TOP OF THE CHARGER WHILE OPERATING. DAMAGE TO THE CHARGER OR BATTERIES COULD OCCUR.**

 **WARNING: THE CHARGER MUST BE SET UP FOR THE PROPER USER SPECIFICATIONS BEFORE STARTING THE INITIAL CHARGE.**

The charger can be mounted on a shelf, countertop, floor, wall, or relay rack. The charger case includes four (4) cushioned feet that are designed to prevent marring of mounting surface and to absorb vibration. The case has built-in rear mounting flanges at the rear for wall and rack mounting.

#### **Wall mounting**

The mounting flanges each have two (2) keyhole slots. These are designed to conveniently engage a 1/4" (6mm) diameter bolt. The dimensions are pattern of mounting flange keyhole slots is shown in Figures 4.1 & 4.2

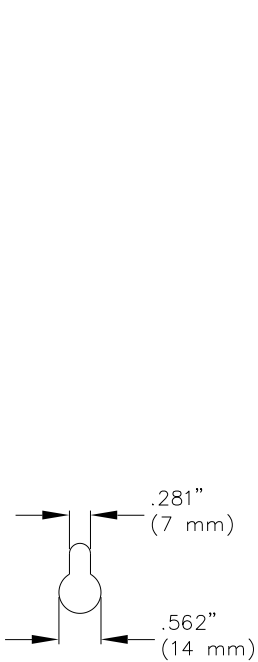

**Figure 4.1**

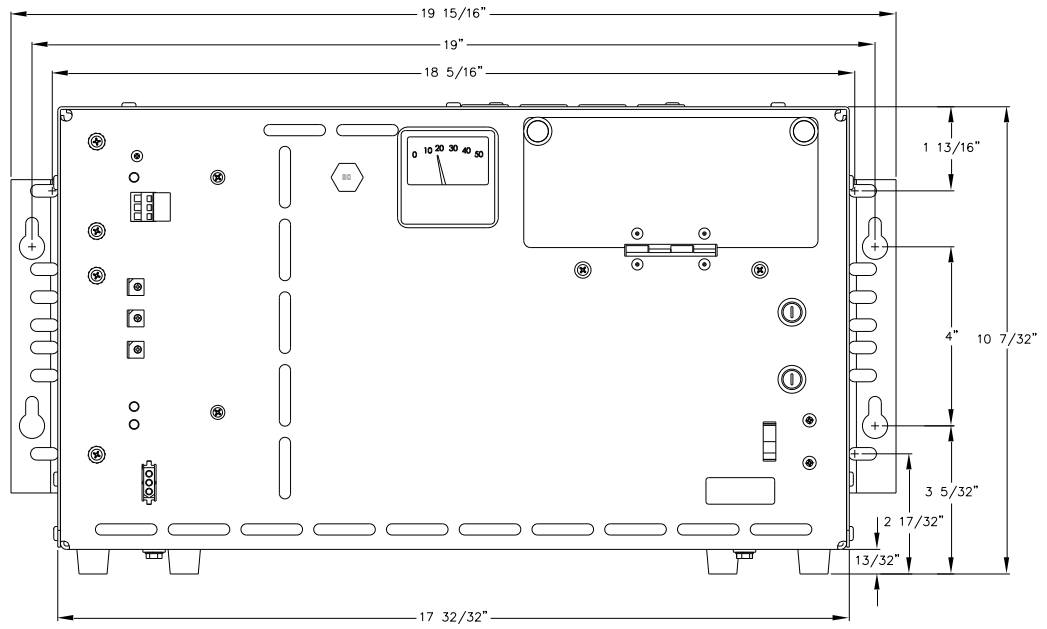

**Figure 4.2**

### Rack Mounting

The charger can be mounted to a standard Electronic Industries Association (EIA) 19" (483mm) rack system using the fasteners provided by the rack manufacturer. The horizontal spacing of the vertical rows of holes is specified by EIA-310 at 18-5/16" (18.312)(465.1mm). The mounting flanges are configured for an EIA 19" (483mm) rack for a forward mounting arrangement (note: the width from the outer edge to one mounting flange to the outer edge of the other mounting flange is 19-15/16"). Fasteners to match the thread of the rack should be used in all 7 rack mounting horizontal slots on each of the 2 mounting flanges (14 rack mounting slots total) to maximize the mounting integrity. The fasteners should be torqued to 22 inch-pounds. The dimensions and pattern of the mounting flange rack mounting slots is shown in figures 4.2 and 4.3

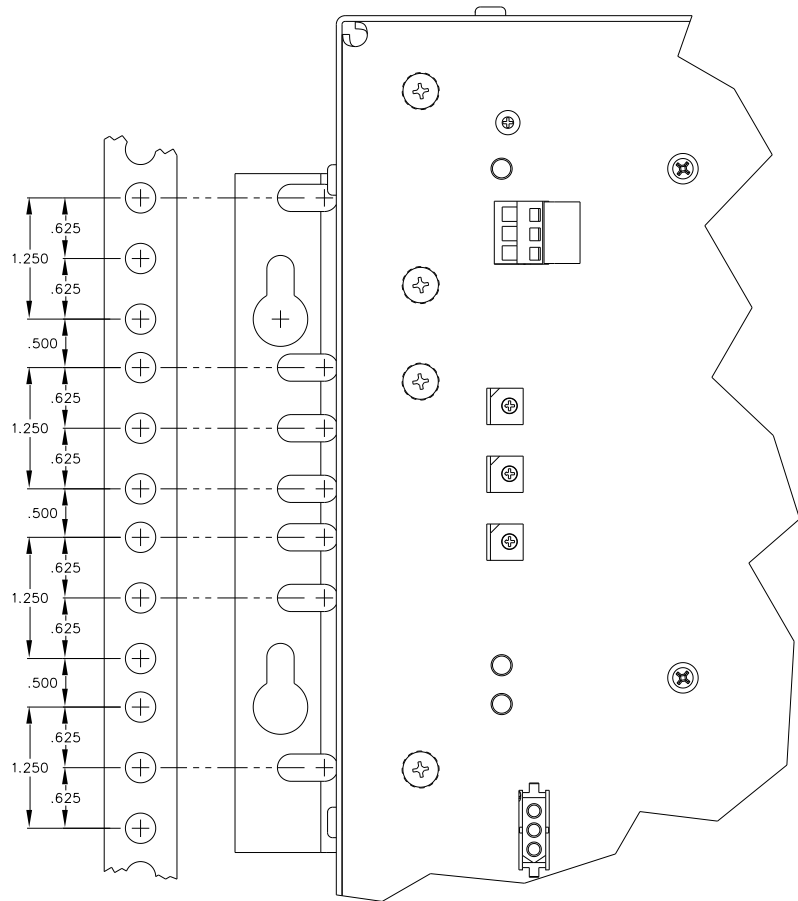

**Figure 4.3**

## 5. AC ELECTRICAL SUPPLY

The charger must be connected to a single-phase, 50/60/100 Hertz AC power source, which can be either 115 or 230 VAC depending on the charger input voltage selection switch setting. Use an 8 AWG wire for the AC power input. Quarter-inch (1/4") ring terminals are required for proper connection to the AC input and ground binding posts (A.A.R.) located on the front of the charger. Open the small door cover on the front of the charger by pulling out on the push tabs. Connect the AC power terminals on the two posts on the right, as marked on the panel behind the posts. Connect the AC ground to the terminal lug provided.

**⚠ WARNING: FAILURE TO PROPERLY CONNECT THE AC VOLTAGE CONDUCTORS COULD CAUSE SERIOUS DAMAGE TO THE CHARGER. BE SURE TO SET THE VOLTAGE SELECTION SWITCHES ON THE FRONT OF THE CHARGER TO THEIR PROPER POSITION.**

**⚠ WARNING: DO NOT OPERATE THE CHARGER WITHOUT PROPER GROUNDING. IMPROPER GROUNDING CAN RESULT IN THE RISK OF AN ELECTRIC SHOCK.**

## 6. DC OUTPUT

The DC output wires, 6 AWG or larger, are connected on the two left-most binding posts as marked on the panel behind the posts (positive on the left and negative on the right). The DC cables should have quarter-inch (1/4") ring terminals for connecting them to the binding posts. Check to make sure the polarity of the DC output wires are the same as those connected to the battery. The charger will not operate in a reversed polarity condition. **WHEN CONNECTING THE DC WIRES TO THE CHARGER WITH THE AC POWER DISCONNECTED, A SPARK MAY OCCUR.** This is caused by the output capacitors being charged by the batteries. If the DC polarity is reversed, a circuit breaker will protect the charger from internal damage. Correct the reversed wires and push the circuit breaker button back in. Close the door cover on the front of the charger after tightening all of the binding post nuts.

**⚠ WARNING: DO NOT TOUCH THE CHARGER'S TERMINALS OR AN ELECTRICAL SHOCK COULD OCCUR. A VOLTAGE IS PRESENT ON THE DC TERMINALS EVEN AFTER THE AC IS DISCONNECTED BECAUSE OF THE ENERGY STORED IN THE CAPACITOR.**

## 7. TEMPERATURE PROBE

The external temperature probe is an optional way of extending battery life by using temperature compensation. One end of the temperature probe cable has a three-pin plug, which plugs into a receptacle labeled TEMP PROBE on the front of the charger. The other end of the cable has the temperature sensor sealed in a terminal.

**⚠ WARNING: IT IS IMPORTANT TO MOUNT THE TEMPERATURE PROBE ON THE BATTERIES FOR PROPER TEMPERATURE COMPENSATION. IF THIS CANNOT BE DONE, LOCATE THE PROBE AS LOW AS POSSIBLE IN THE BUNGALOW OR CABINET.**

### Terminal-Type Probe

The terminal-type probe should be attached to the negative (-) battery post near the center of the battery pack. If the threaded stud is long enough above the battery jumper nut, attach the probe with another nut. Torque this nut to proper specifications. If the stud is too short, the nut holding the jumper wire will need to be removed. Open or remove the load and charging circuits to the batteries. Remove the nut holding the jumper and add the probe, then torque the nut to the proper specifications. Then close or connect the load and charging circuits back to the batteries.

**Securely fasten the temperature probe cable to protect the probe from being torn from the battery.** Secure the probe's cable to a fixed object to ensure the probe will not be pulled loose. Use a cable tie mount on the battery or on the adjacent battery, if necessary.

## 8. OPERATION

The battery charger is adjustable with the three rotary switches on the front of the charger. The switches (settable between 10.00 and 17.00) determine the float voltage for the batteries. **SET THE FLOAT VOLTAGE TO THE BATTERY MANUFACTURER'S SPECIFIED VOLTAGE FOR 77°F.** The charger will then electronically charge the batteries to the voltage specified on the switches. To set the switches, use a small screwdriver and turn the switch so that the arrowhead on the slot is pointing to the desired number. Set the switches in the following manner: If the desired battery voltage is 13.38 volts, set the top switch to 3, the middle switch to 3, and the bottom switch to 8 (see the Figure 8.1). This will provide you with the proper charging voltage. The tens digit is always a one (1) and cannot be changed. **BE SURE EACH SWITCH IS SET ON A NUMBER AND NOT BETWEEN**

**NUMBERS.** If a switch is set between numbers, the output current will go to zero and the yellow Charging LED will flash.

The charger does not have a power switch. When the AC power is applied to the charger, the DC output will start and the yellow Charging LED will be on. The Charging LED will go off if the charger stops outputting current. To turn off the charger, disconnect the AC power source.

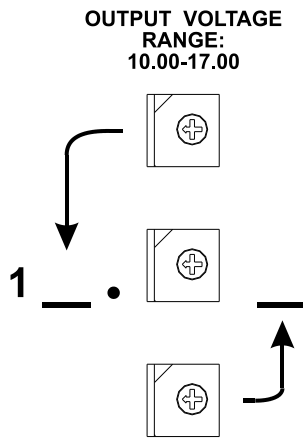

Figure 8.1

**9. CURRENT MONITOR/ALARM**

The ELC-12/40-M-D battery charger includes an integrated current monitor/alarm that monitors the output current of the charger. If the charger output falls below the current limit setting, a green LED indicator is turned off and a Form C, dry contact alarm relay is actuated. The current limit adjustment, LED, and relay terminals are accessible on the front of the charger (see Figure 9.1).

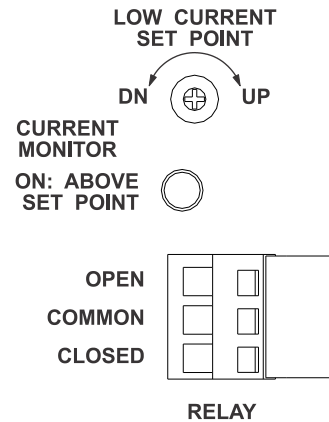

Figure 9.1

**Relay Terminal Remote Wiring**

The OPEN, COMMON, and CLOSED relay contacts have push-in type terminals for remote wiring. The relay contacts are rated for 1A at 30 Vdc or 0.5A at 120 Vac. A small screwdriver (3/32 inch maximum blade width) is required to insert or remove a wire from a relay terminal.

**⚠ WARNING: BE CAREFUL! IF AN UNINSULATED METAL TOOL CONTACTS BOTH THE GROUNDED CHARGER CASE AND A RELAY TERMINAL PUSH-IN TAB, THIS WILL CAUSE A POTENTIALLY DAMAGING AND/OR DANGEROUS ELECTRICAL SHORT.**

**Current Monitor/Alarm Operation**

Table 9.1 outlines the operation of the LED and relay based on the status of the current monitor. All relay contact states are with reference to the terminal strip COMMON.

Current Monitor Status	LED	CLOSED Relay Contact	OPEN Relay Contact
Charger output exceeds the current limit setting	On	Closed	Open
Charger output falls below the current limit setting (and AC power is present at the charger)	Off (after approx. 30 seconds)	Open (after approx. 30 seconds)	Closed (after approx. 30 seconds)
AC power is removed from the charger	Off (immediately)	Open (immediately)	Closed (immediately)

Table 9.1

## Current Limit Adjustment

The current limit adjustment should be set to a level that is below the charger output when sourcing the minimum DC load of the system and floating the fully charged battery set. The current limit adjustment is factory-set to approximately 400 mA (fully clockwise), which should work for most applications. If the minimum DC load of the system combined with the battery float current is above approximately 500 mA, leaving the current limit adjustment at the factory setting of 400 mA is recommended. If an adjustment is required, it can be adjusted between approximately 400 mA and 70 mA. Setting the current limit adjustment below approximately 100 mA is not recommended due to internal charger DC current that can still exist and be monitored if the charger DC output is disconnected from the load and battery set.

### Adjustment Procedure

A small screwdriver (3/32 inch maximum blade width) is required to change the current limit adjustment.

With AC power applied to the charger input and the charger DC output connected to the load and fully charged battery set, monitor the charger output current until it stops decreasing and levels off at the minimum system current. Ensure that the current limit adjustment is turned fully clockwise, which will set the current limit at approximately 400 mA. If the LED is on and the CLOSED relay contact is closed when the current limit adjustment is turned fully clockwise, leave it in that position. If the LED is off and the CLOSED relay contact is open when the current limit adjustment is turned fully clockwise, turn it slowly counterclockwise until the LED turns on and the CLOSED relay contact closes. Turn the current limit adjustment approximately 1/8 of a turn counterclockwise from this switching point. Remove AC power from the charger to verify that the current monitor/alarm is functioning. The LED should turn off and the CLOSED relay contact should open.

### Current Monitor Specifications

CURRENT MONITOR/ALARM RELAY CONTACT RATINGS:

1A at 30 Vdc

0.5A at 120 Vac

TERMINAL CONNECTIONS:

20 – 16 AWG wire, strip length of .312 - .359 inches (8 – 9 mm)

## 10. MAINTENANCE

The battery charger requires minimal maintenance. It should be kept clean and all connections are to be periodically tightened. **BE SURE THE CHASSIS IS SECURELY GROUNDED.** If any problem cannot be resolved, consult the nearest NRS service agent at 1-800-357-3572.

## 11. SERVICING

If the battery charger operates improperly, follow the steps below.

- a. Begin by checking the voltage switches to verify their settings against the specifications of the batteries.
- b. Check the AC voltage selection switch for the proper setting.
- c. Check the fuses to make sure they have not blown.
- d. Check the circuit breaker to see if it has opened and push it in to reset it, if necessary.
- e. Check the polarity between DC output and the battery and make sure their connections are tight.
- f. Remove the small cover on the front of the charger and make sure all of the binding posts nuts are tight.
- g. If the steps above do not solve the problem, contact your local NRS service agent at 1-800-357-3572.

## 12. CHARGER SPECIFICATIONS

AC INPUT VOLTAGE:

115 Vac (108-128) or 230 Vac (216-256)

AC INPUT CURRENT:

12.0 amps for 115 Vac (full power)

6.0 amps for 230 Vac (full power)

AC INPUT FREQUENCY:

50/60/100 Hertz (single phase)

AC LINE REGULATION:

For a constant output current at 2.23 volts/cell

22% for 6 cells

AC FUSES:

10 Amp slow blow

DC OUTPUT:

Voltage range 10.00 – 17.00 ± 0.1 volts

Current Maximum 40.0 ± 1 amps

DC OUTPUT RIPPLE (at battery terminals):

1.0V p-p at 40.0 amps, 12.0 volts

0.1V p-p at 2.0 amps, 13.38 volts

TEMPERATURE COMPENSATION:

3mV per °F per cell

WEIGHT, NET: 60 lbs

### 13. PARTS LIST

The following is a list of parts found in the NRS Model ELC-12/40-M-D. When replacing a part, USE ONLY ORIGINAL FACTORY REPLACEMENT PARTS of the correct size and rating.

<b>PART NO.</b>	<b>QTY.</b>	<b>DESCRIPTION</b>
38418S	1	CASE ASSEMBLY MODEL 27560
18696S	1	SHUNT ASSEMBLY
31462S	1	CONTROL MODULE (W/ ELECTRONIC BOARD #21175)
38309S	1	CURRENT MONITOR MODULE (W/ ELECTRONIC BOARD #27545-01)
38308S	1	CURRENT MONITOR MODULE MOUNT
38811S	1	CONTROL CABLE, CURRENT MONITOR
05322S	2	FUSEHOLDER ASSEMBLY
15028S	2	FUSE, 10 AMP
39388S	1	CIRCUIT BREAKER ASSEMBLY
31457S	1	AC SWITCH ASSEMBLY
27319S	1	AMMETER, 50 AMP
14197S	4	BUSHING, 1"
29741S	1	TEMPERATURE TRANSDUCER, 10' (W/ TERMINAL)
29742S	1	TEMPERATURE TRANSDUCER, 30' (W/ TERMINAL)
14742S	1	HEATSINK ASSEMBLY, W/ SCR, 9" WIRE
15194S	1	HEATSINK ASSEMBLY, W/ SCR, 21" WIRE
23074S	1	SCR ASSEMBLY, 50 AMP, 21" WIRE
23073S	1	SCR ASSEMBLY, 50 AMP, 9" WIRE
32199S	1	OUTPUT CAPACITOR, C, 40,000 UF, 35V
39337S	1	CAP ASSEMBLY, W/ DIODE ASSEMBLY
14759S	1	VARISTOR ASSEMBLY, VR2, 130V
31463S	1	TAP STRIP ASSEMBLY
31309S	1	VARISTOR ASSEMBLY, VR1, 320V
31301S	2	DOOR LATCH, BASE
31302S	2	DOOR LATCH, STUD

# 14. WIRING DIAGRAM

ELC-12/40-M-D

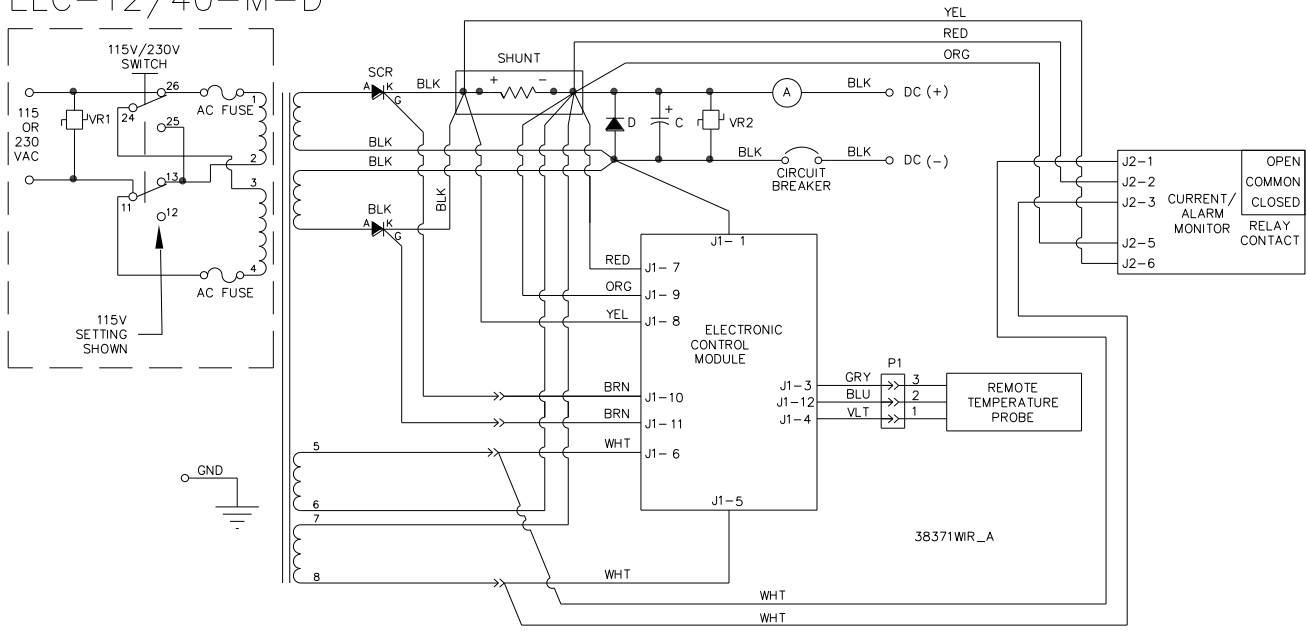

J1-1	BLACK	- BATTERY
J1-2	BLACK	NOT USED
J1-3	GRAY	TEMP PROBE (-)
J1-4	VIOLET	TEMP PROBE (+)
J1-5	WHITE	AC XFRMR #8
J1-6	WHITE	AC XFRMR #5
J1-7	RED	+ BATTERY
J1-8	YELLOW	SHUNT +
J1-9	ORANGE	SHUNT -
J1-10	BROWN	SCR
J1-11	BROWN	SCR
J1-12	BLUE	TEMP PROBE SENSE

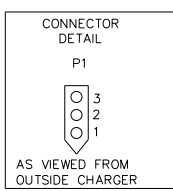

C	OUTPUT CAPACITOR
D	DIODE ASSEMBLY
VR1	VARIATOR
VR2	VARIATOR