

SCR/SCRF SERIES

FLOAT BATTERY CHARGERS

**Industry's First Choice for
Time-Tested Proven Reliability**



**Single-Phase Input
Three-Phase Input**

**Applications for:
Utility & General Industry**

- Switchgear
- Engine starting
- Emergency lighting
- Alarm systems
- Railroad service
- UPS

**Communications &
Telecommunications**

- Radio
- Telemetry
- Microwave
- Telephone

**Computers & Control
Systems**

- Uninterruptible power systems

HINDLEPOWER

HindlePower SCR/SCRF Series of industrial float chargers is designed to automatically control charging rates for a wide variety of battery types and to simultaneously provide full-rated output for both continuous and intermittent dc loads.

The chargers are constant voltage devices with automatic current limiting. Voltage regulation and current limiting are controlled by solid-state integrated circuitry to assure maximum performance in minimum space.

The SCR/SCRF Series is ideally suited to utility, communications and other stationary charger applications.



DESIGN FEATURES

Component Selection

- Electronic and electrical components are substantially derated to assure long life and reliability. Typical MTBF is 100,000 hours minimum. Components are selected or designed to provide a system life expectancy in excess of 30 years.

Modular Construction

- Control circuits, alarm circuits and electrical sub-assemblies are printed circuit board wired or modularized with plug and socket connections for easy serviceability.

Standard Sub-assemblies

- Control modules and many electrical sub-assemblies are standardized across the entire range of charger sizes. This minimizes spare parts inventory and simplifies maintenance.

Durable

- Front panels are recessed to prevent accidental damage to meters and controls. Standard cabinets are NEMA-1 enclosures of heavy-gauge phosphatized steel with an attractive, long-lasting acrylic enamel finish.

Easy Troubleshooting

- A complete service manual, color-coded wiring, test-point identification and circuit-symbol labeling of internal components make troubleshooting easy.

Ease of Adjustment

- Tap adjustments are not required. Output float voltage, equalize voltage, current limit and alarm levels are potentiometer adjustable.

Ease of Access

- Internal components and connections are easily accessible and/or removable through a hinged front door that opens approximately 180 degrees for easy serviceability.

Ease of Installation

- Cabinets are floor, wall or rack mountable and equipped with knockouts for cable or conduit entrance. Input, output and remote alarm connections are wired to easily accessible, internal terminal blocks.

ENVIRONMENTAL SPECIFICATIONS

Operating Ambient Temperature

- 32°F to 122°F (0°C to 50°C) without derating

Storage Temperature

- -40°F to 185°F (-40°C to 85°C)

Operating Altitude

- 3300 feet (1000 meters) above sea level without derating

Relative Humidity

- 5% to 95% (without condensation)

Audible Noise

- Less than 65dBA at any point 5 feet from any vertical surface of enclosure. Typical values measure 55 to 60dBA at 100% load.

Ventilation

- Units rated 300Adc output or less are convection cooled via NEMA-1 vent openings in cabinet. Units rated 400Adc output or greater have fan-assisted convection cooling with overheat-audible alarm and remote-alarm contacts. (Automatic charger shutdown due to overheat is optional.)

ELECTRICAL SPECIFICATIONS

AC Input

- Standard transformers are available with taps for nominal voltages as listed below.

Single-Phase Voltages:

- 120/220 – 240V 47 – 63Hz
- 480V 57 – 63Hz
- 120/208 – 240V 47 – 63Hz(optional)

Three-Phase Voltages:

- 208 – 240V 57 – 63Hz
- 380 – 416V 47 – 63Hz
- 480V 57 – 63Hz

Chargers are wired and circuit protected for one nominal input voltage and frequency to be specified at time of order.

Output Regulation

- ±0.5% of DC voltage setting maintained with input line variations of -12%, +10% voltage and/or ±5% frequency
- ±0.5% of DC voltage setting maintained with load variations from no load to full load
- ±1.0% of DC voltage setting maintained against the combined variations of line, load and temperature

Output Transient Response & Recovery

- ±5.0% max. of DC voltage setting maintained with step load changes from 20% to 100% load

- Recovery to ±2.0% of DC voltage setting typically 200msec
- Recovery to steady state DC voltage setting typically 500msec
- Overshoot of DC voltage setting is not present at turn-on due to “soft-start” feature.

Output Current Limit

- The electronic current limiting circuitry is factory set at 110% of rated output. It is continuously adjustable from 90% to 120% of rated load.

Output Ripple and Electrical Noise*

- Unfiltered (SCR Series): Output ripple voltage is less than 10% RMS for single-phase input SCR units. Output ripple voltage is less than 3% RMS for three-phase input SCR units.
- Filtered (SCRF Series): Output ripple voltage is 30mVrms or less for all SCRF units. Electrical voice band noise is less than 32dBnC using C-message weighting network.

**Measured when connected to a battery with an 8-hr., Amp-Hour rating of 4 times the full load current rating of the charger.*

Random Parallel Operation

- SCR/SCRF Series Chargers may be random parallel operated with other chargers of similar regulation and current limit characteristics. Equal load sharing by two SCR-SCRF chargers requires the addition of the forced load sharing option.



Battery Eliminator Operation

- SCR/SCRF Series Chargers will operate as DC power supplies without batteries. Addition of the Filtered Battery Eliminator option will reduce ripple, when used as a battery eliminator, to the greater of 0.06% or 30mV.

SCR/SCRF Battery Charger DC Output Table

VDC Nominal	Float Adjustment Range (VDC)	Equalize Adjustment Range (VDC)	ADC Size Cell Available (1)		Lead-Acid Cell Capability (3) (No. of Cells)		Ni-Cd Cell Capability (3) (No. of Cells)	
			1φInput	3φInput	Normal	Reduced VPC	Normal	Reduced VPC
12	10.5 - 14.5	11.3 - 16	6 to 100	60 to 100	5 - 6		8 - 10	
24	23 - 30	24.5 - 32	6 to 100	50 to 600	11 - 13		17 - 20	21
48	46 - 60	48 - 64	6 to 100	50 to 600	22 - 26	27	34 - 40	42
130	115 - 140	124 - 150	6 to 50	25 to 600	55 - 62	63	86 - 94	98
260	230 - 280	245 - 300	6 to 25	16 to 300	110 - 124	126	172 - 188	196

(1) The discrete Adc sizes offered within the ranges listed above are: 6, 12, 16, 20, 25, 30, 35, 40, 50, 60, 75, 100, 125, 150, 175, 200, 250, 300, 400, 500, 600Adc. All sizes are rated at 100% load. Some current ratings are not available on certain chargers. Consult factory or current price list for exact offerings.

(2) Based on Lead-Acid Float of 2.15 to 2.25V/Cell and equalize of 2.25 to 2.4V/Cell.

(3) Based on Ni-Cd Float of 1.35 to 1.45V/Cell and Equalize of 1.50 to 1.60V/Cell.

SCR/SCRF BATTERY CHARGER STANDARD ACCESSORIES

AC On Indicating Light

- Green front panel indicator

AC Input Circuit Breaker

Single-Phase Input:

- Two-pole, 7500 AIC, UL Listed 100A-Frame

Three-Phase Input:

- Three-pole, 7500 AIC, UL Recognized 100A-Frame
- Three-pole, 25000 AIC, UL Listed 225A-Frame
- Three-pole, 30000 AIC, UL Listed 400A and 600A-Frame

DC Output Fuses

- Two-pole, fast-acting, current-limiting rectifier type

AC and DC Surge Suppressors

MOV Type

AC Withstand:

- 240Vac or less: 1500Vpk - 1.2x20 μ sec pulse
- Over 240Vac: 3000Vpk - 1.2x20 μ sec pulse

DC Withstand:

- All DC outputs: 4000Vpk - 2x10 μ sec pulse

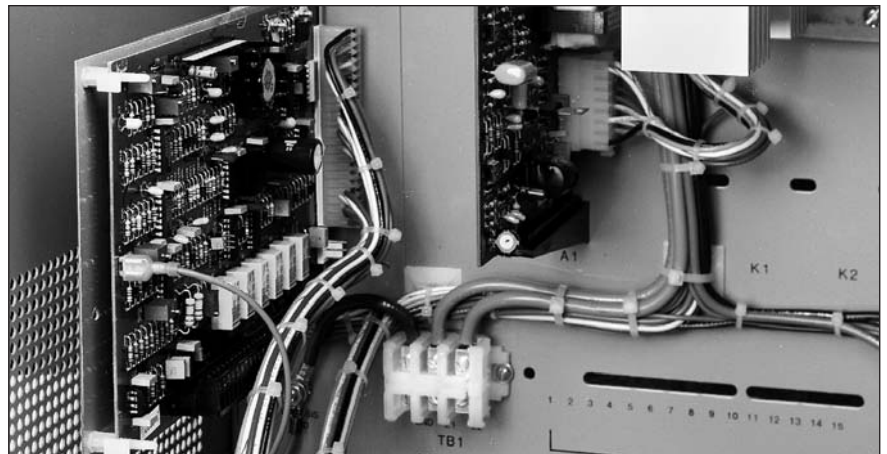

Typical internal construction detail showing combined alarm-status charger monitor option

DC Output Ammeter and Voltmeter

- Front panel, 2% accuracy, 3.5-inch case

Manual Float/Equalize Switch

- Front panel toggle switch

Float and Equalize Adjustment Potentiometers

- Two front panel mounted, lockable adjustment potentiometers

Current Limit Adjustment Potentiometer

- Internally mounted, with easily accessible adjustment

DC Output Blocking Diode

- Standard SCR/SCRF Series feature prevents battery from discharging back through the filter and rectifier when charger is "off" due to AC power failure or charger malfunction.

DC Output Protection Diode

- Prevents damage to charger and battery due to reversed polarity connections

Color-Coded Internal Wiring

- 600 Volt, color-coded, polyvinylchloride (PVC) wiring is standard.

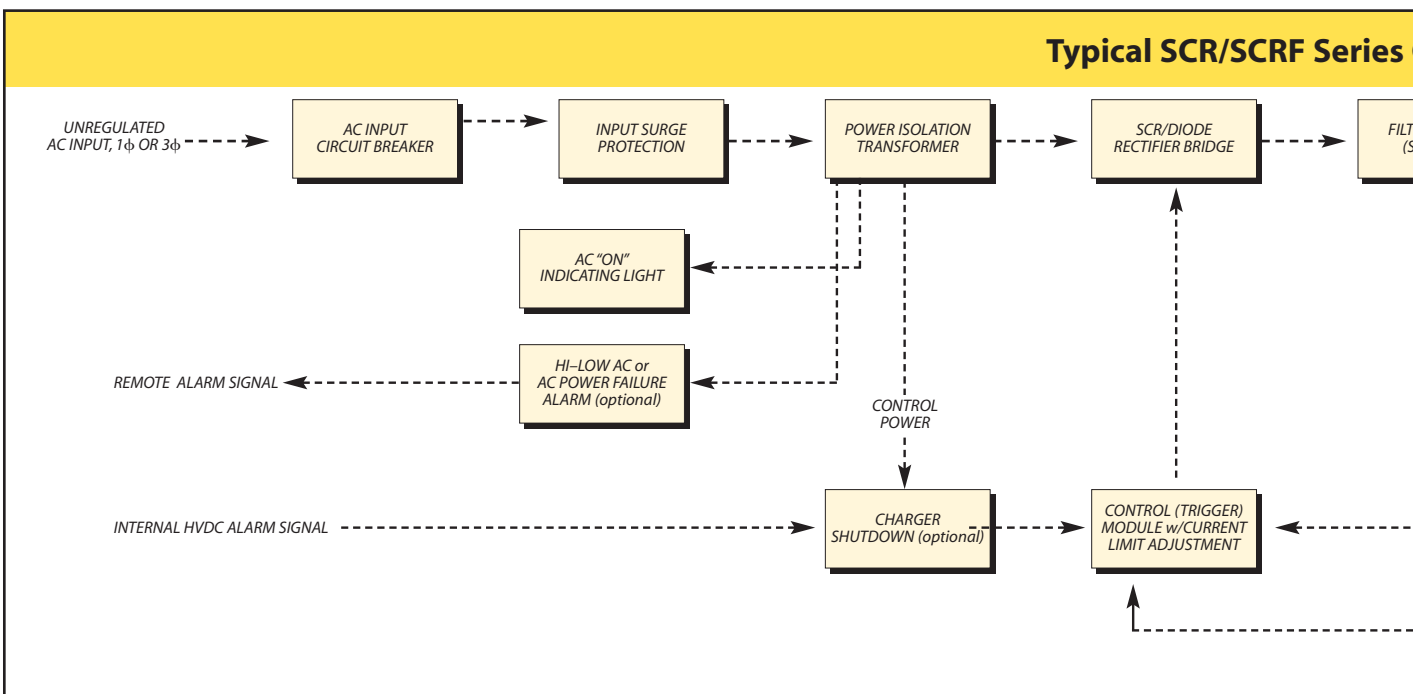

Typical SCR/SCRF Performance Curves

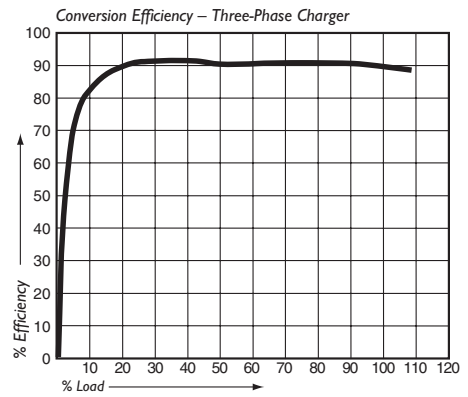
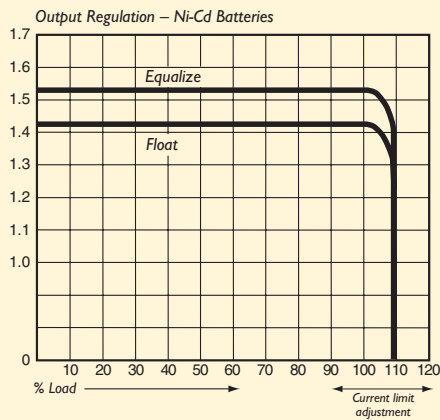
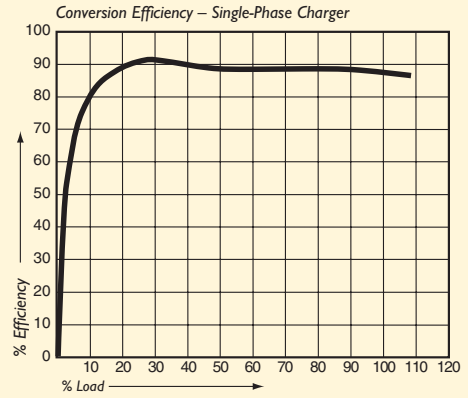
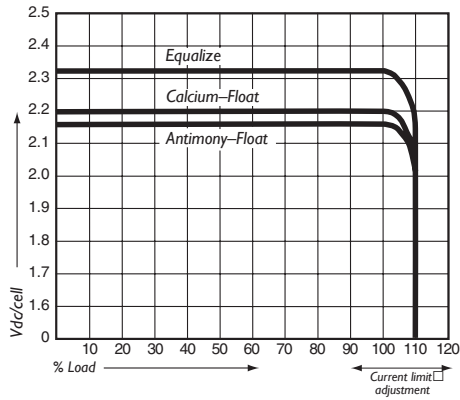

One-Line Circuit Diagram

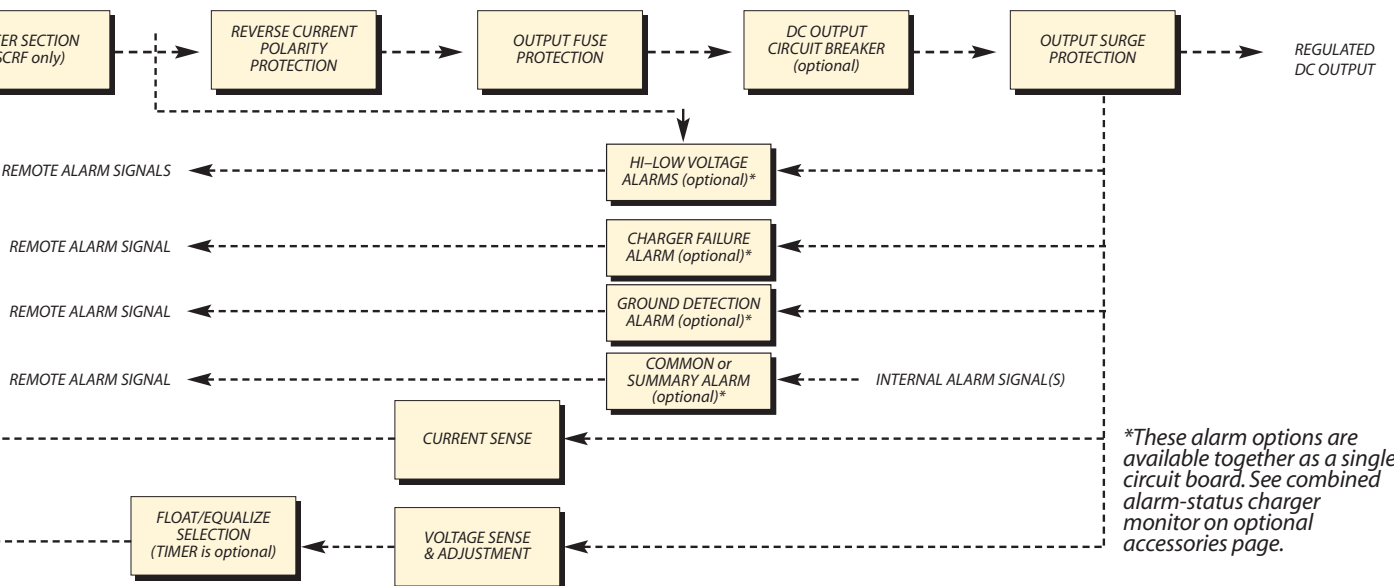

SCR/SCRF BATTERY CHARGER OPTIONAL ACCESSORIES

Alarm Relays for Remote Indication*

Available with or without front panel alarm indicating lights

- **AC Power Failure Alarm**
Provides alarm state when AC power fails or AC breaker is open
- **DC Ground Detection Alarms**
Provides alarm state when a ground fault has occurred at either the + or – output terminal
- **High-Low DC Voltage Alarms**
Provides high alarm state when battery is being overcharged and low alarm state when battery is near end of discharge
- **Charger Failure Alarm (No DC Current)**
Provides alarm state when charger output current is less than 2% of rated output for 30 seconds or more. Will also activate with AC power failure and/or DC breaker or fuse open.
- **Battery Discharging Alarm**
Provides alarm state when battery discharge current exceeds the charger recharge current
- **End of Discharge Alarm**
Provides alarm state when battery has discharged to lowest system voltage limit
- **DC Current Limit Alarm**
Provides alarm state when charger output current reaches the current limit setting
- **Common (Summary) Alarm**
Provides a single alarm state when any one or all monitored alarm conditions exist on charger

*Alarm circuits provide one (1) set of dry form "C" contacts (SPDT) wired to a terminal strip for customer termination. Alarm circuits with two (2) sets of dry form "C" contacts (DPDT) are available without indicating lights at additional cost. Standard relay contacts are rated for resistive loads of: 1A @ 120Vac, 2A @ 28Vdc, 1A @ 52Vdc, 0.1A @ 130Vdc. Auxiliary relays are available for use with alarm circuits when alarm load exceeds the standard contact rating. Auxiliary relay contacts are rated for resistive loads of: 5A @ 120Vac, 5A @ 28Vdc, 2A @ 52Vdc, 0.5A @ 130Vdc.

CASM, Combined Alarm - Status Monitor*

The following alarm relays are available combined together on a single board. Each relay has one (1) set of isolated, dry form "C" contacts (SPDT) wired to a terminal strip for customer connection. Two (2) sets of form "C" contacts (DPDT) are available at additional cost, as are one (1) set of latching relays.

- **High-Low AC Voltage Alarm Relay**
With high and low indicating lights, 15-second time delay on alarm, auto reset

- **High DC Voltage Alarm Relay**
With indicating light, 15-second time delay on alarm, auto reset
- **Low DC Voltage Alarm Relay**
With indicating light, 15-second time delay on alarm, auto reset
- **Ground Detection Alarm Relay**
With (+) ground detection indicating light and (-) ground detection indicating light, 15-second time delay on alarm, auto reset
- **Charger Failure Alarm Relay**
With indicating light, 30-second time delay on alarm, auto reset
- **Common Alarm Relay**
Summary alarm relay for any one or all alarms on this board.

*Alarm contacts are rated for 0.5A @ 120V AC or DC. Indicating lights are red LEDs front panel mounted. A "lamp test" switch is provided for verifying operation of indicating lights. Customer terminal strip is rated 15A @ 120V AC or DC to accommodate #14AWG maximum wire. This option may be ordered without ground detection for DC systems that are referenced to ground.

DC Ground Detection for Local Indication

- **Ground Detection Switch for Front Panel DC Voltmeter Indication**
Measures voltage from + or – output terminals to common ground
- **Ground Detection Indicating Lights with Ground Test & Lamp Test Switch**
Front panel lamps indicate + or – output ground fault with switch in "ground test" position. In "lamp test" position both lights are verified as operational.

Equalize Timers

- **0-72hr. Manual Equalize Timer w/ or w/o Float Equalize Indicating Lights**
Replaces float/equalize switch. Charger automatically switches from "equalize" to "float" at end of set time interval.
- **0-72hr. Line Failure Auto-Equalize Timer w/Float Equalize Indicating Lights**
Charger is switched to equalize for a set time interval after power is interrupted for 10 seconds or more. Equipped with "float reset" and "equalize" override switches.
- **0-72hr. Current Limit Auto-Equalize Timer w/Float Equalize Indicating Lights**
Charger is switched to equalize for a set time interval after charger is in current limit for 10 seconds or more. Equipped with "float reset" and "equalize" override switches.

AC Fuse

- Two-pole AC fuse for single-phase, 3-pole AC fuse for 3-phase

DC Circuit Breaker

Two-pole DC breaker is installed with one-pole standard fuse:

- 5000 AIC, UL Listed 100A-Frame
- 10000 AIC, UL Listed 250 & 400A-Frame
- 14000 AIC, UL Listed 600 & 800A-Frame
- Optional higher AIC circuit breakers are available.

Forced Load Sharing

- Chargers operating in parallel share load to within 2% of output current of each charger.

High DC Voltage Charger Shutdown

- A contact closure from a high DC voltage alarm activates the shutdown circuit and charger output current goes to zero.

Filtered Battery Eliminator

- Output ripple voltage is 30mVrms or 0.06% of nominal output voltage, whichever is higher, without battery connected.

Input Lightning Arrestors

- Provides additional input protection against lightning-induced transients, ANSI 37.90A

Surge Withstand Capability

- Additional surge protection to meet performance requirements of IEEE-472 SWC specification

AC Input Voltmeter and/or Ammeter

- Front-panel, 2% accuracy, 3.5-inch case, 1% switchboard 4.5-inch case, 0.2% digital

Additional Optional Accessories

- Special input voltages and frequencies
- Device nameplates
- Special paint
- Special high-interrupting capacity
- Fungus proofing (tropicalization)
- NEMA-4 or NEMA-12 cabinets
- (AIC) circuit breakers
- Drip-proof cabinet shields
- Special hypalon internal wiring, switchboard type
- 1% accuracy panel or switchboard meters
- Alarm buzzer
- Cabinet heater strips
- Export packing

TYPICAL SCR/SCRF BATTERY CHARGER INTERNAL CONSTRUCTION DETAIL

STYLE 1A CABINET CONSTRUCTION

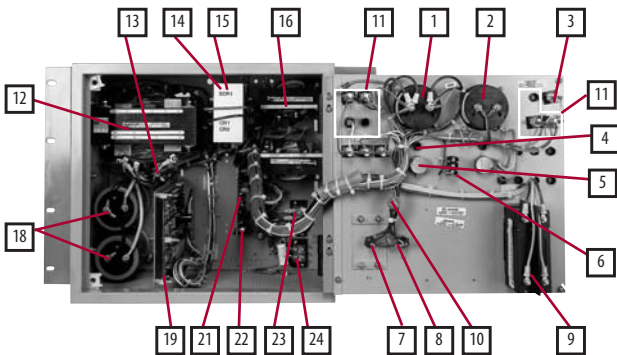

STYLE 1B CABINET CONSTRUCTION

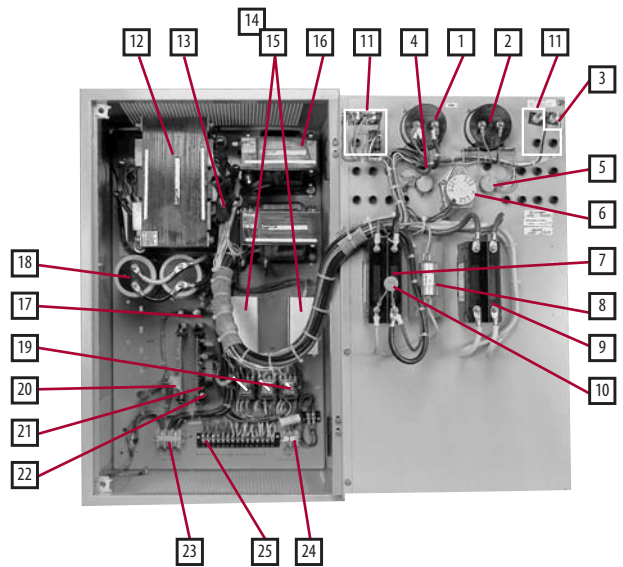

1. DC AMMETER
2. DC VOLTMETER
3. AC POWER "ON" LIGHT
4. EQUALIZE ADJUST LIGHT
5. FLOAT ADJUST POT
6. EQUALIZE TIMER (optional)
FLOAT EQUALIZE SWITCH (standard)
7. DC CIRCUIT BREAKER (optional)
8. DC FUSE(S)
9. AC CIRCUIT BREAKER
10. DC SURGE SUPPRESSOR
11. STATUS INDICATING LIGHTS
& SWITCHES (optional)
12. POWER ISOLATION TRANSFORMER
w/AC RECONNECTION T.B.
13. AC SURGE SUPPRESSORS
14. SCR RECTIFIER/HEAT SINK ASSEMBLY
15. POLARITY & BLOCKING
DIODE ASSEMBLIES
16. FILTER CHOKE(S)
17. BLEEDER RESISTOR
18. FILTER CAPACITORS
19. ALARM RELAY(S) (optional)
20. ALARM CONTROL MODULES (optional)
21. CONTROL MODULE
22. CURRENT LIMIT ADJUST POT
23. INPUT LINE & GROUND TERMINALS (TB1)
24. OUTPUT TERMINALS (TB2)
25. REMOTE ALARM TERMINALS (TB3)

STYLE 2 CABINET CONSTRUCTION

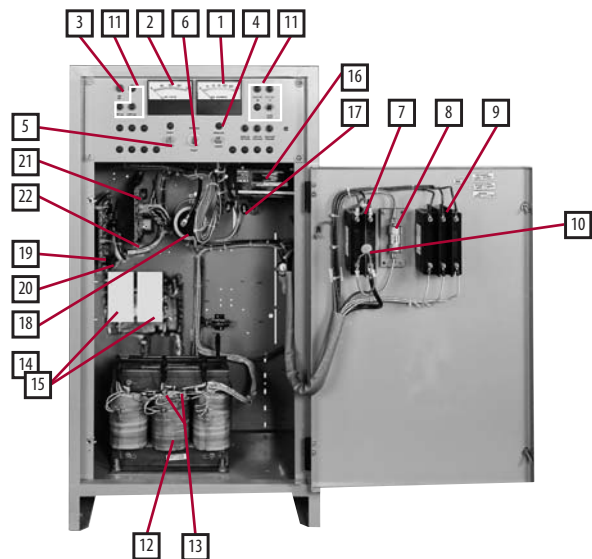

SCR/SCRF Battery Charger Heat Loss, Size, & Weight Data Table

SCR/SCRF Battery Charger Heat Loss, Size, & Weight Data Table																
12Vdc				24Vdc			48Vdc			130Vdc			260Vdc**			
Ampere Rating*	Heat Loss BTU/hr.*	Cabinet Style	Shipping Weight (approx.) lbs. (kg)	Heat Loss BTU/hr.*	Cabinet Style	Shipping Weight (approx.) lbs. (kg)	Heat Loss BTU/hr.*	Cabinet Style	Shipping Weight (approx.) lbs. (kg)	Heat Loss BTU/hr.*	Cabinet Style	Shipping Weight (approx.) lbs. (kg)	Heat Loss BTU/hr.*	Cabinet Style	Shipping Weight (approx.) lbs. (kg)	
Single-Phase Input																
6	70	1A	80 (36)	95	1A	90 (41)	170	1A	105 (48)	370	1B	125 (57)	670	2	230 (104)	
12	135	1A	90 (41)	200	1A	105 (48)	330	1A	120 (54)	740	1B	160 (73)	-	-	-	
16	180	1A	98 (44)	260	1A	115 (52)	440	1B	135 (61)	990	1B	210 (95)	1790	2	320 (145)	
20	230	1A	105 (48)	320	1A	125 (57)	540	1B	160 (73)	1230	1B	220 (100)	-	-	-	
25	290	1B	120 (54)	400	1B	135 (61)	680	1B	170 (77)	1540	1B	230 (104)	2790	3	490 (222)	
30	340	1B	130 (59)	480	1B	150 (68)	810	1B	190 (86)	1850	1B	250 (113)	-	-	-	
35	400	1B	135 (61)	560	1B	160 (73)	950	1B	210 (95)	2150	2	340 (154)	-	-	-	
40	460	1B	145 (66)	640	1B	180 (82)	1080	1B	220 (100)	-	-	-	-	-	-	
50	570	1B	160 (73)	800	1B	190 (86)	1350	2	245 (111)	3080	2	440 (200)	-	-	-	
60	680	2	185 (84)	960	2	210 (95)	-	-	-	-	-	-	-	-	-	
75	850	2	205 (93)	1200	2	245 (111)	2020	2	330 (150)	-	-	-	-	-	-	
100	1130	3	280 (127)	1600	3	320 (145)	2700	3	440 (200)	-	-	-	-	-	-	
Three-Phase Input																
16	-	-	-	-	-	-	-	-	-	-	-	-	1260	2	350 (159)	
20	-	-	-	-	-	-	-	-	-	-	-	-	-	-	-	
25	-	-	-	-	-	-	-	-	-	1260	2	300 (136)	1960	3	510 (231)	
30	-	-	-	-	-	-	-	-	-	1510	2	330 (150)	-	-	-	
35	-	-	-	-	-	-	-	-	-	1760	2	355 (161)	2750	3	560 (254)	
40	-	-	-	-	-	-	-	-	-	2010	2	380 (172)	-	-	-	
50	-	-	-	740	2	210 (95)	1230	2	255 (116)	2510	3	500 (227)	3920	3	590 (268)	
60	600	2	215 (98)	880	2	240 (109)	1480	2	320 (145)	3010	3	520 (236)	-	-	-	
75	750	2	240 (109)	1100	2	275 (125)	1850	2	350 (159)	3760	3	550 (249)	5880	4	890 (404)	
100	990	3	315 (143)	1470	3	360 (163)	2460	3	460 (209)	5010	3	680 (308)	7840	4	1000 (454)	
125	-	-	-	1840	3	425 (193)	3080	3	500 (227)	6260	3	750 (340)	-	-	-	
150	-	-	-	2200	3	480 (218)	3690	3	540 (245)	7510	4	915 (415)	11800	5	1480 (671)	
175	-	-	-	2570	3	510 (231)	4300	3	600 (272)	8760	4	1010 (458)	-	-	-	
200	-	-	-	2940	3	550 (249)	4920	3	650 (295)	10100	4	1100 (499)	15700	5	1610 (730)	
250	-	-	-	3670	4	600 (272)	6150	4	750 (340)	12600	4	1400 (635)	-	-	-	
300	-	-	-	4400	4	710 (322)	7380	4	860 (390)	15100	5	1500 (680)	23600	5	1950 (885)	
400	-	-	-	5870	4	780 (354)	9830	4	950 (431)	20100	5	1650 (748)	-	-	-	
500	-	-	-	7340	4	850 (386)	12300	5	1350 (612)	25100	5	1820 (826)	-	-	-	
600	-	-	-	8800	4	925 (420)	14800	5	1500 (680)	30100	5	1950 (885)	-	-	-	

*Heat loss in BTU/hr. is stated for nominal number of cells at float voltage and 100% dc load current. **Consult factory for ampere and voltage ratings up to 1000A and 600V.

Ordering Information

Specify:

- Charger model number: X SCR X XXX—XXX—X
 "1" or "3" phase input
- Omit for unfiltered, or add "F" for filtered
 "012""024""048""130" or "260" nominal Vdc output
- "006" to "600" rated Adc output
- Omit if not required, or add "-E" for filtered battery eliminator (SCRF units only)
- Nominal input (Vac) and frequency (Hz)
- Number and type of battery cells
- All optional accessories required on charger

Consult factory for higher dc voltage output and dc current outputs. Specifications and performance data subject to change without notice.

These products and others distributed by

Cabinet Dimensions

CABINET STYLE	1A	1B	2	3	4	5
TYPE MOUNTING	Wall***	Wall***	Floor***	Floor	Floor	Floor
DIMENSIONS (inches)	H	15	26 ¹ / ₄	37 ³ / ₈	49	62
	W	18 ¹ / ₄	19	20 ³ / ₈	32	42
	D	12 ¹ / ₈	15 ¹ / ₂	14 ³ / ₄	24	24

***Rack-mounting cabinet is optional for these styles. For detailed CAD drawings of all SCR/SCRF NEMA-1 type enclosures (and optional NEMA-4/12 type enclosures), please visit the support section of our web site www.hindlepowerinc.com.

